



hdrpano iOS APP Phantom 4 Pro iPAD 2018



PHANTOM 4 PRO



FW V 01.05.0300 (01.05.0600 doesn't work = camera busy error)

hdrpano APP 1.2.3

Kolor Autopano Giga 4.4

PTGui 11

Pano2VR 5.2.5

xml-creator 1.6

360° PHOTOGRAPHY

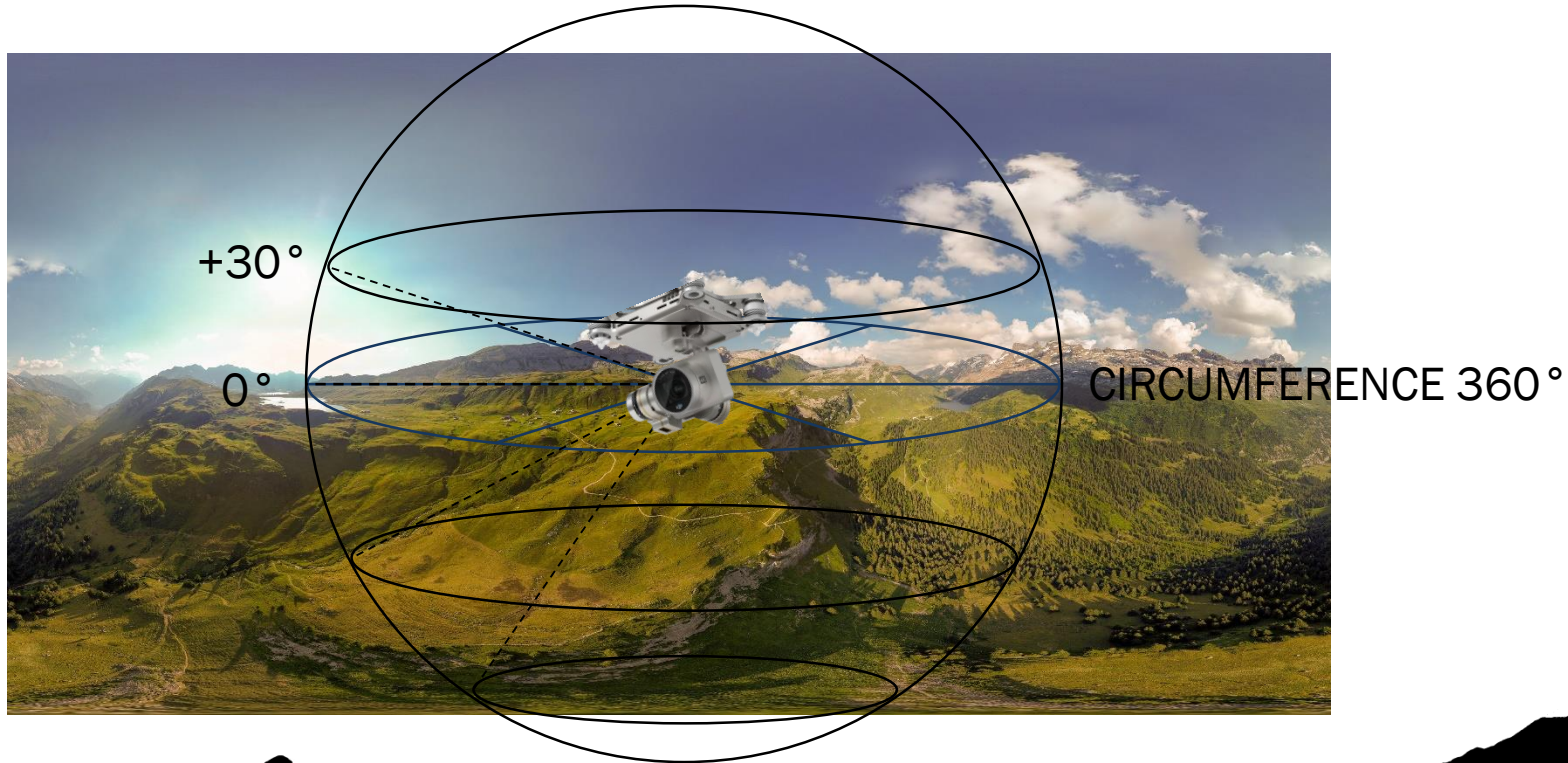

FULL SPHERICAL MATH

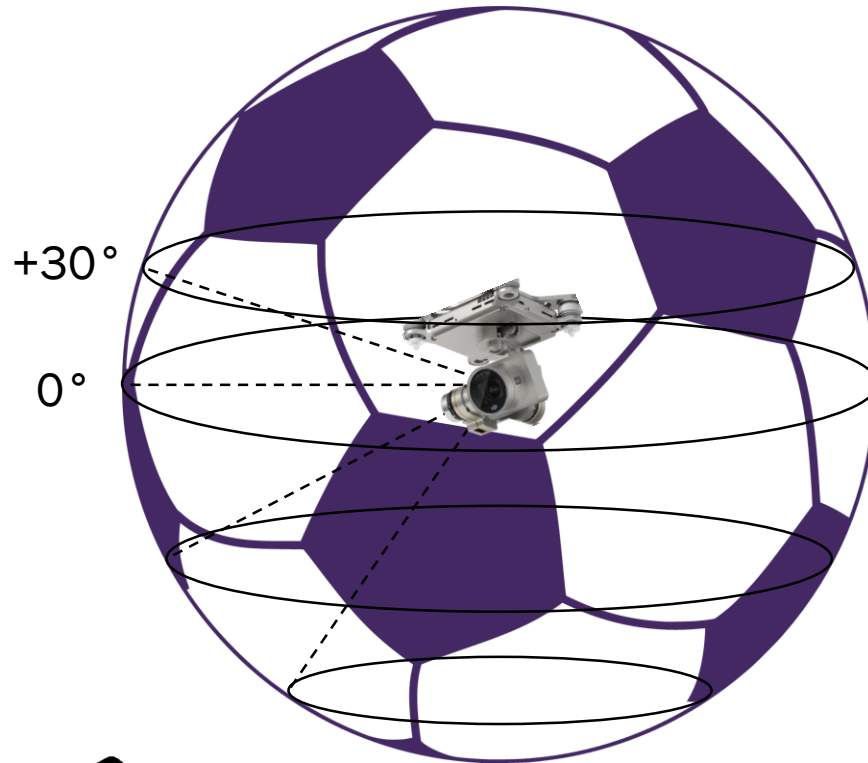

GRID SYSTEM

UP DOWN
LINEAR

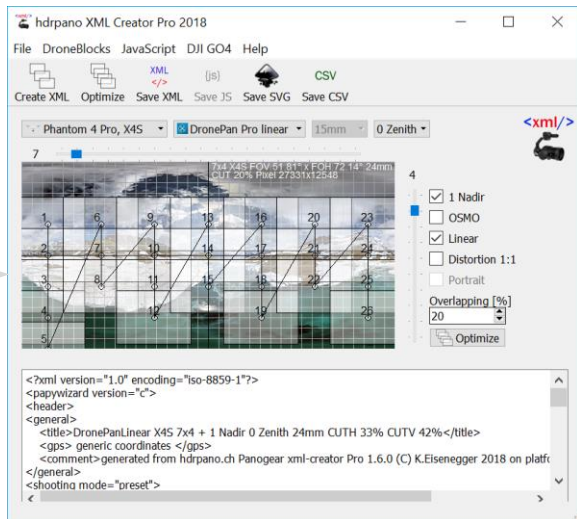

LEFT RIGHT
SPHERICAL

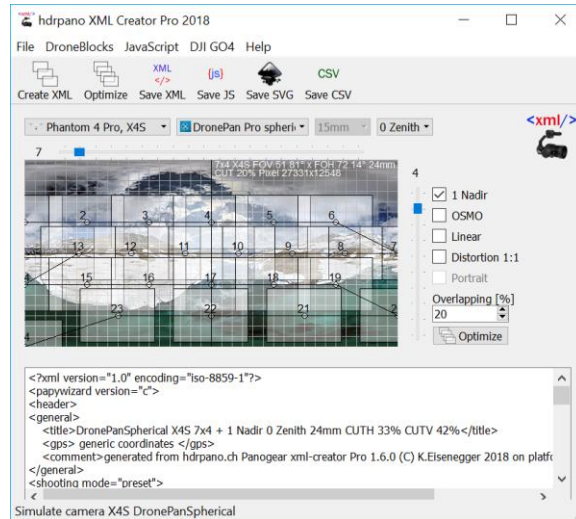

XML FILE

ZENITH

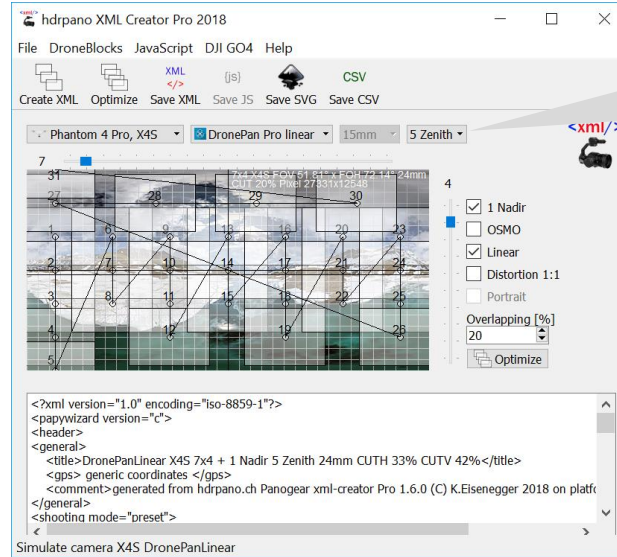
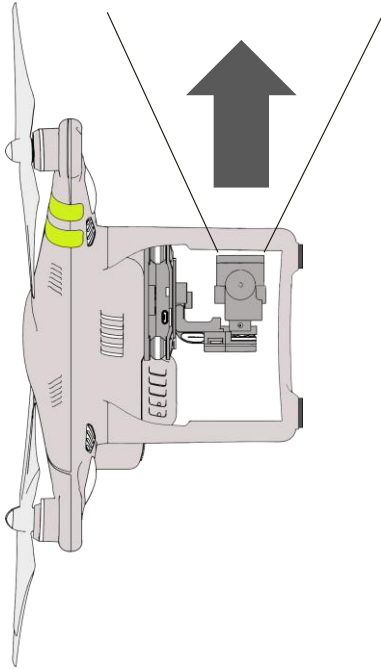

NUMBER OF
ZENITH SHOTS
AFTER LANDING

5 ZENIT YAW STATUS BAR

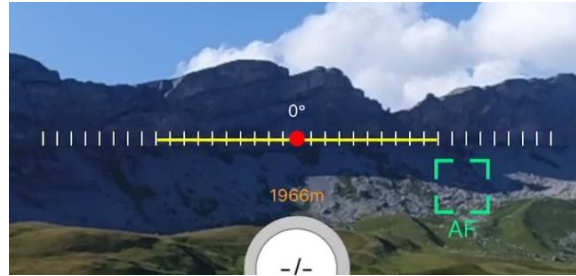
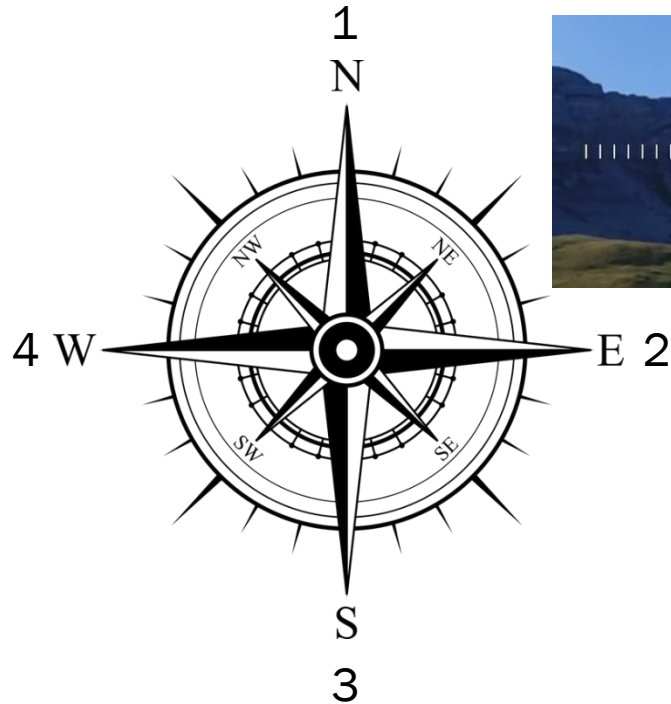

SHOT 1 TO 4 N-E-S-W

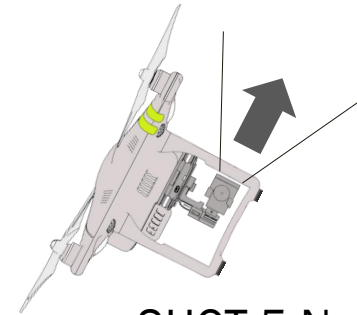

SHOT 5 N

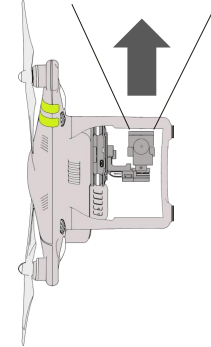

APP VIEW



YAW STATUS BAR

PITCH STATUS BAR

PANO START/STOP

APP VIEW

MISSION
MODE

GIMBAL
RESET

SAVE XML

HIDE/ SHOW
MAP

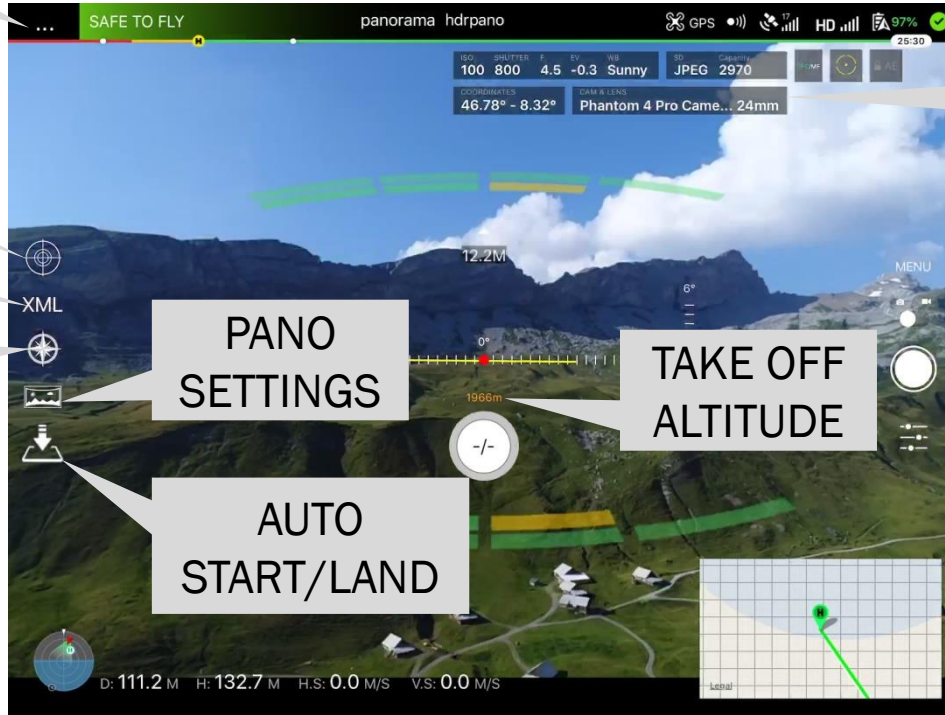

FOCAL
LENGHT

PANO
SETTINGS

TAKE OFF
ALTITUDE

AUTO
START/LAND

PANO SETTINGS

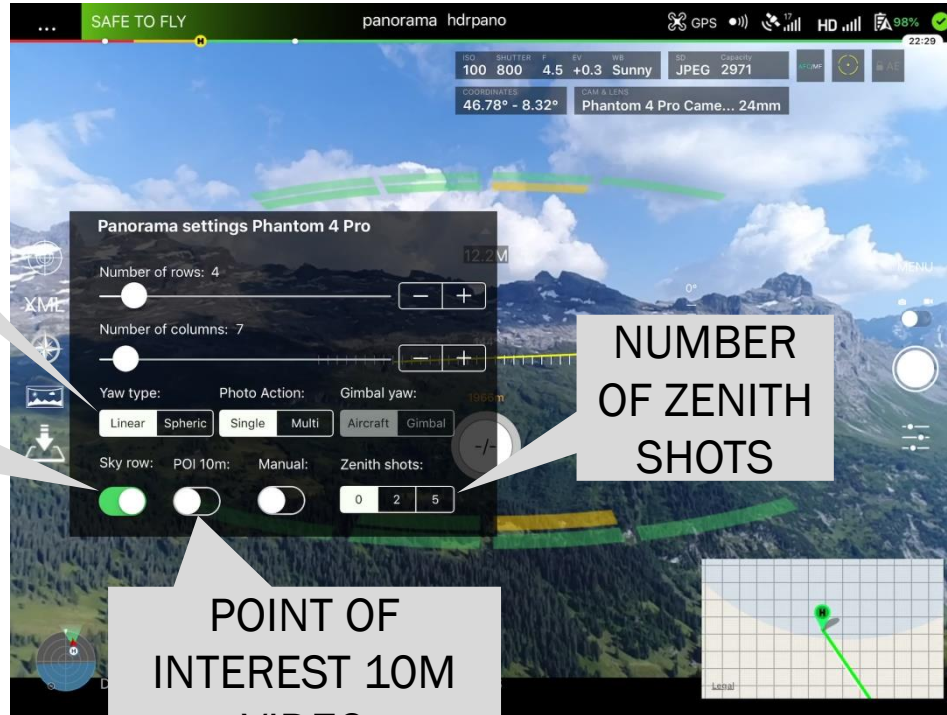

FOR PERFECT CALIBRATED GIMBAL



OVERWRITE
DEFAULT 25°
ONLY FOR P4P

FOCAL



MISSION COMPLETE

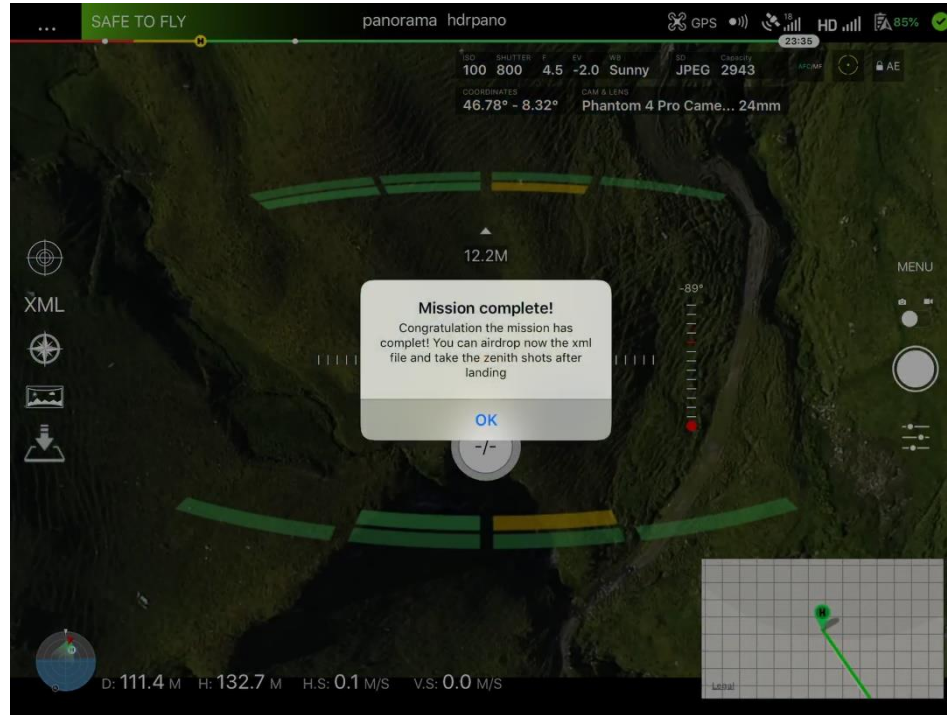

SAVE XML TO DRIVE

FILE NAME

GOOGLE DRIVE

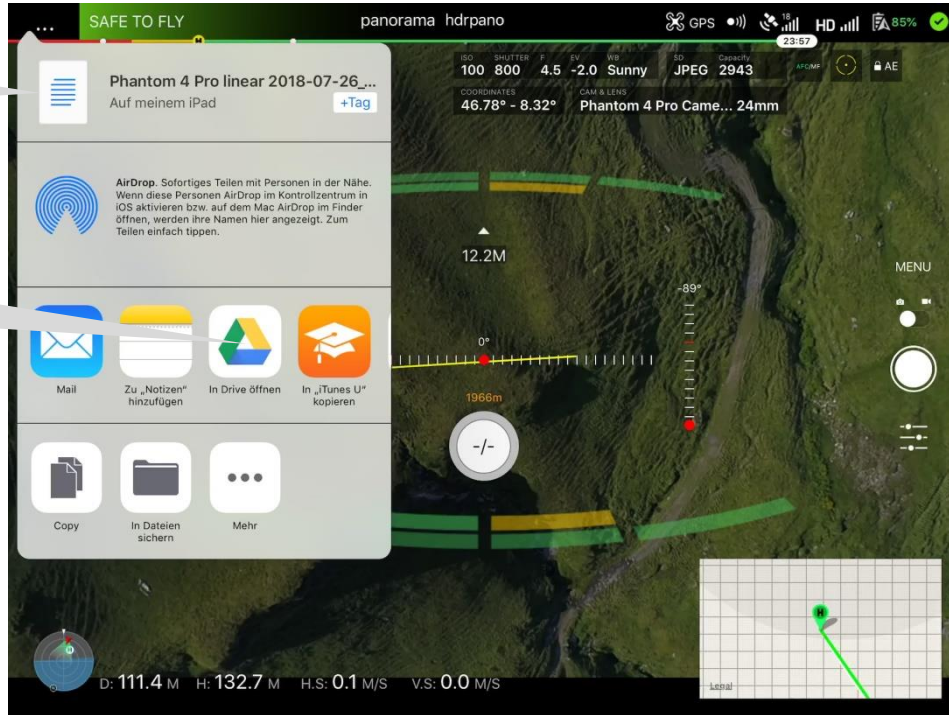

AUTOPANO XML IMPORT

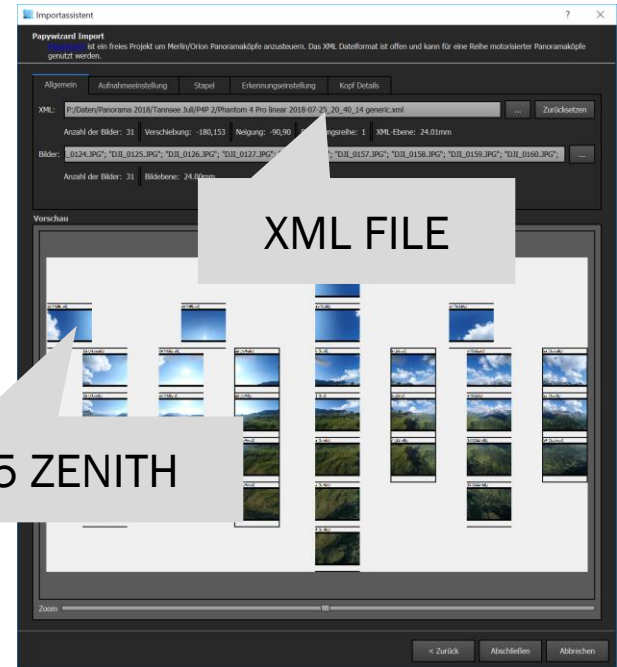
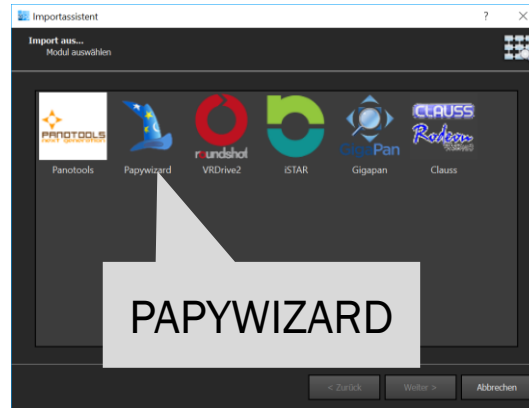
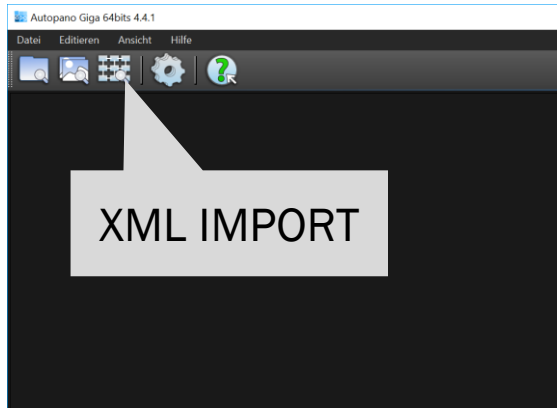

PTGui XML IMPORT

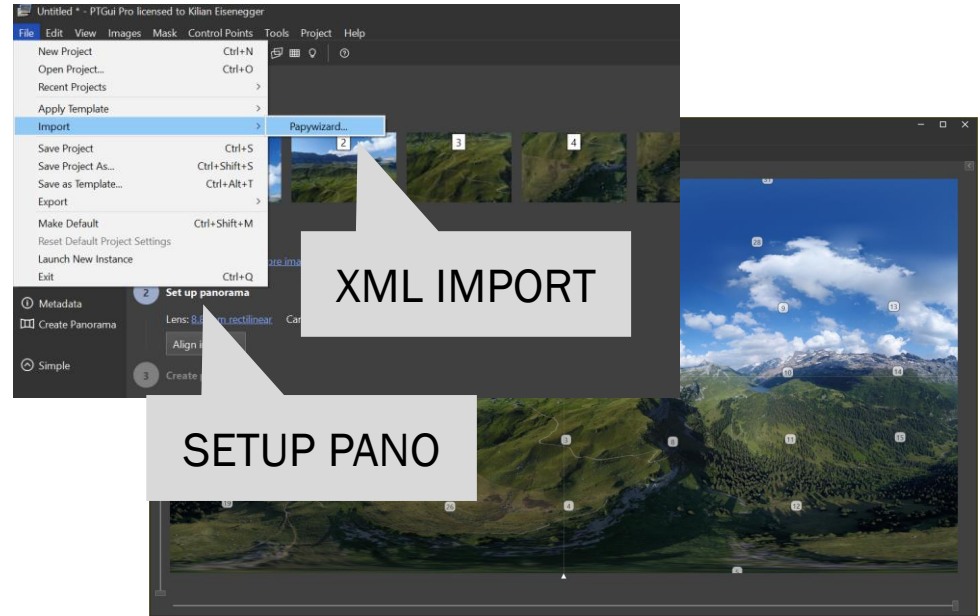
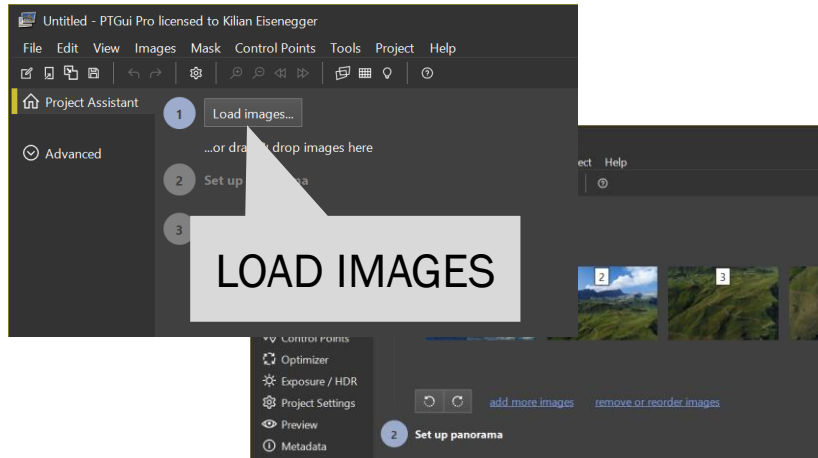

PTGui 5 ZENITH

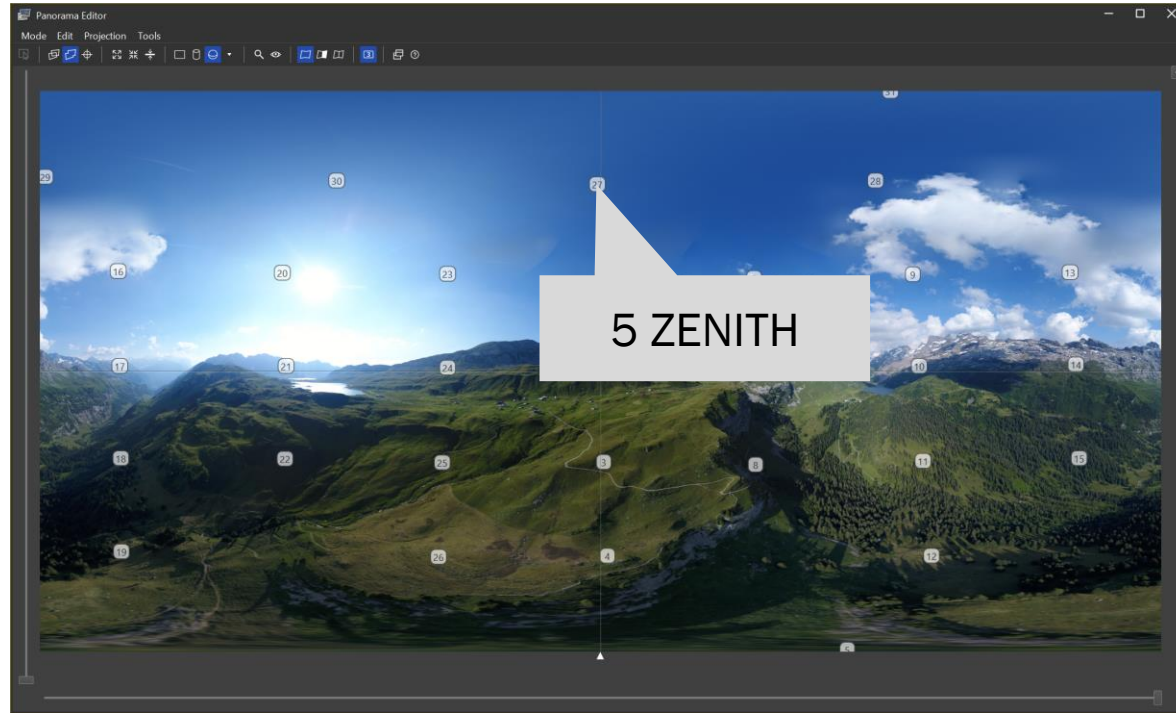

PUPLISH ON STREET VIEW FULL SIZE

Pano2VR

PICTURE DATA

GOOGLE PLACE

VIEW NORTH

GOOGLE MAPS FULL SIZE

